

marantz®

AM/FM STEREO RECEIVERS

Model 2325

Model 2275

Model 2250B



12 things to look for when buying a stereo receiver.

But first look at the nameplate. If it says Marantz 2325, 2275 or 2250B, you can be sure you're getting all twelve points described below. These design concepts often make the difference between acceptable performance and exceptional performance.

POWER AMPLIFIER SECTION

1. Full Complementary Symmetry Output

Assures higher stability, better linearity and lower distortion than the quasi-complementary outputs used in the amplifier sections of most receivers.

Quasi-complementary circuitry tends to generate high order harmonic distortion and is particularly susceptible to crossover distortion. To reduce these types of distortion, manufacturers increase the amount of feedback within the amplifier. Under actual dynamic conditions, however, the amplifier with excessive feedback is prone to higher transient distortion and also lower stability.

In contrast, full complementary symmetry output circuitry requires less feedback by incorporating positive and negative amplifiers which are balanced to mirror-image each other's characteristics. This design produces exceptional linearity, lower total harmonic distortion and lower inter-modulation distortion.

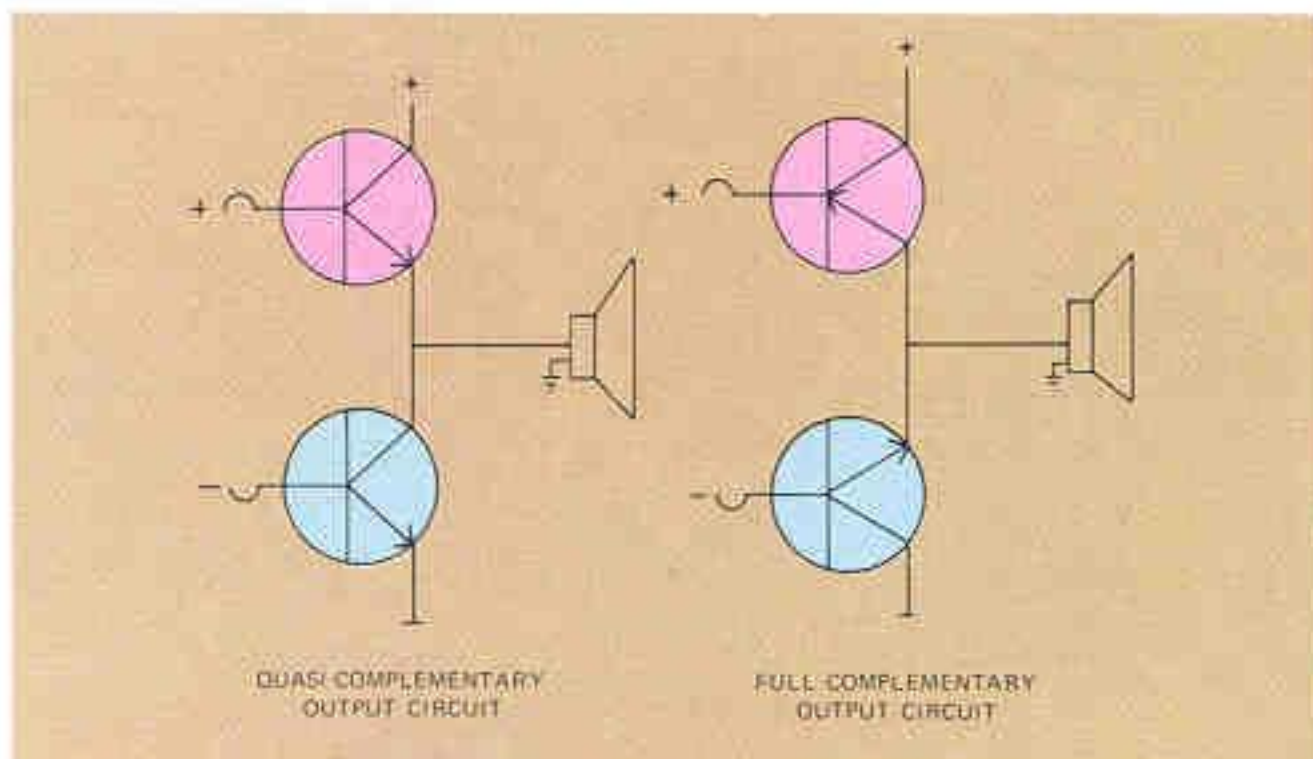

For these excellent reasons, Marantz receivers feature full complementary symmetry design, as used extensively in Marantz Professional Products.

2. Direct Coupled Power Output

Provides wide power bandwidth, excellent low frequency transient response and improved damping factors.

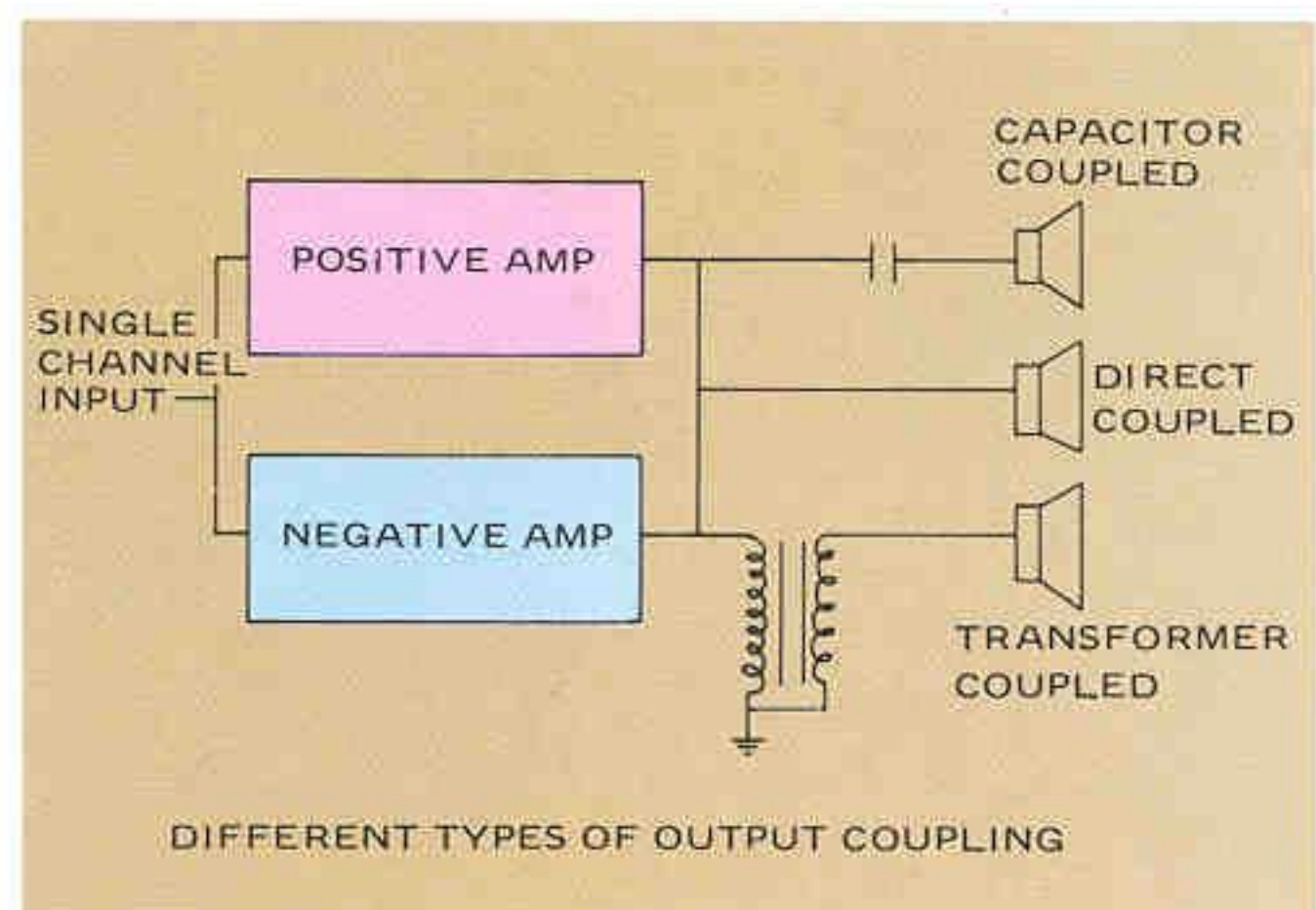

"The direct coupled power output circuitry used in Marantz receivers has eliminated the need for coupling transformers and capacitors and the sound inaccuracies they can cause."

Early transistorized power amplifiers featured one of two types of output design: A transformer or a capacitor was incorporated between the power output stage and the speaker system. However necessary this was for proper output-to-speaker coupling, it tended to limit low frequency power response or to cause degrading phase shift, and thus impair sound accuracy.

Today's more advanced technology has eliminated the need for coupling transformers and capacitors and the sound inaccuracies they can cause.

The sophisticated direct coupled output stages used in Marantz amplifiers assure you of extremely high damping factors at low frequencies and the best possible low frequency response.

3. Heavy-Duty Power Supply

High reserve power supply sections and power output circuitry ensure that Marantz receivers will continue to meet specifications through years of steady performance.

A massive power transformer forms the heart of a dual-balanced positive and negative power supply that symmetrically powers the amplifier stages. Large capacity electrolytic capacitors assure high energy power reserves, while massive heat sinks promote highly reliable, long-term operation even under full power output conditions.

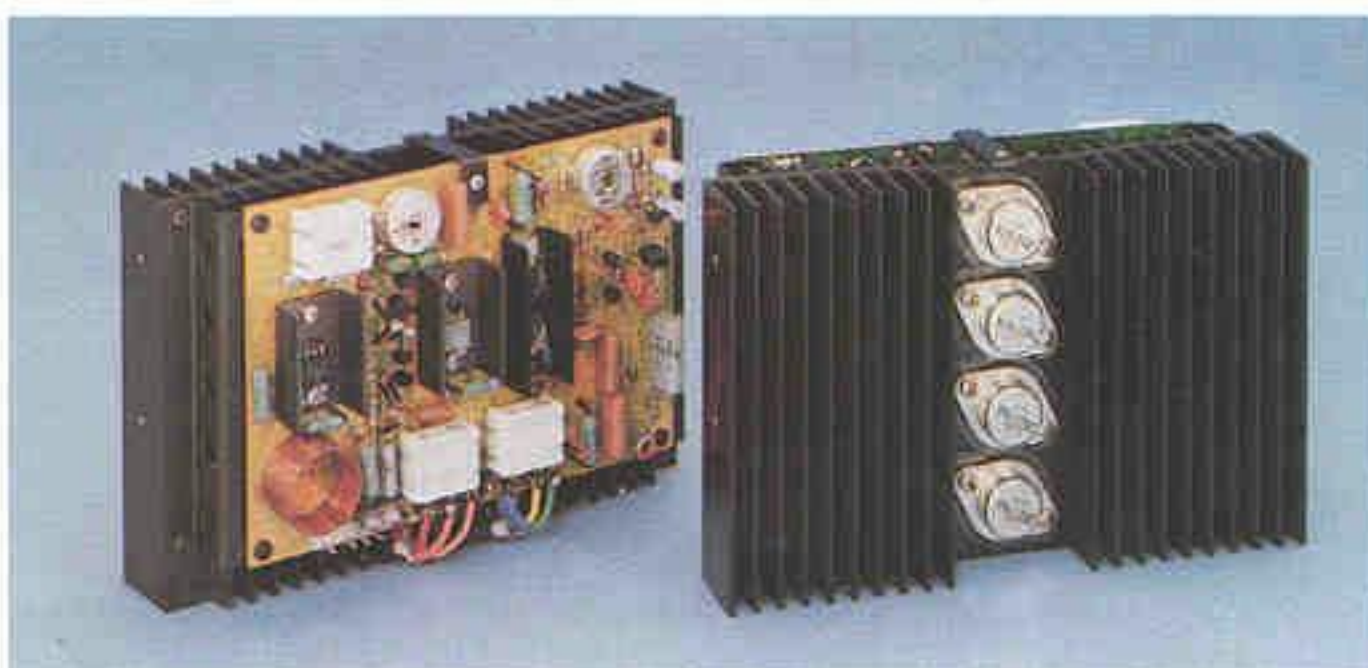

"Full complementary symmetry output assures higher stability, better linearity and lower distortion than the quasi-complementary outputs in most receivers."

TUNER SECTION

4. Steep Quieting Slope

The quieting slope specification measures a tuner's ability to provide good signal-to-noise performance under actual operating conditions. It's a far more reliable indication of performance quality than the IHF (Institute of High Fidelity) sensitivity figure often quoted as the prime specification to consider when evaluating an FM tuner.

The IHF figure gives only the number of microvolts necessary for minimum quality reception: A signal with 3% distortion and noise (30 dB quieting) hardly qualifies as high fidelity. A signal-to-noise ratio in excess of 50 dB (the revised 1975 IHF specification) is generally recognized to be necessary for high quality listening. It is most important then, to examine a receiver's ability to quiet quickly beyond the 30 dB quieting point.

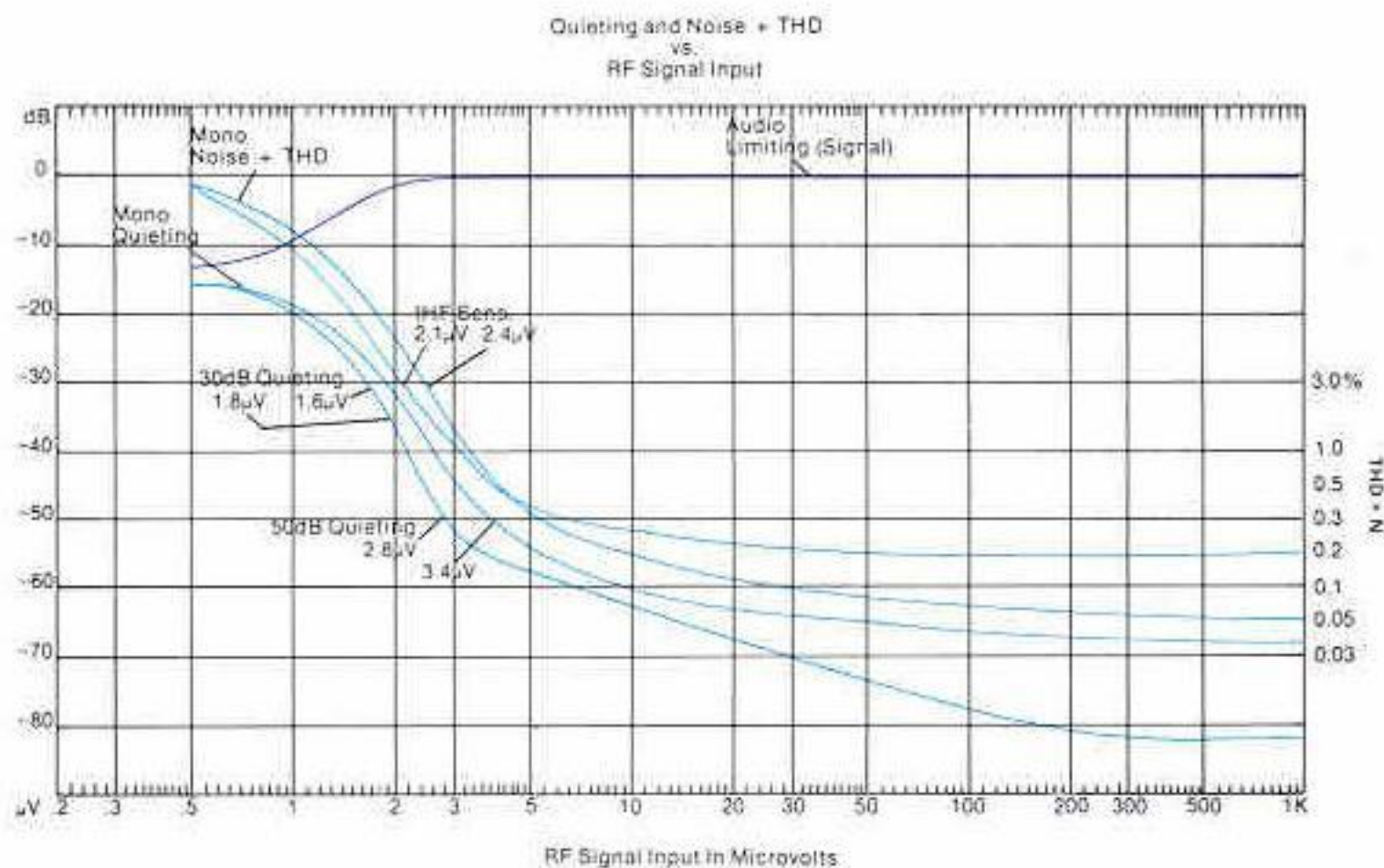

Two tuners with comparable weak signal sensitivities, but significantly different quieting slopes. Tuner A, with an IHF sensitivity of 2.4 uV, appears to deliver slightly less performance than tuner B, with an IHF sensitivity of 2.1 uV, or specified 0.3 uV better. However, tuner A's steeper quieting slope indicates that it gets quieter, faster than tuner B— a significant advantage under actual performance conditions.

Quieting slope sensitivity figures measure the signal-to-noise ratio in the crucial five to 500 microvolt range, where the majority of usable broadcast signals fall. The steeper the slope, the quieter, and therefore the more listenable, the station.

5. Highly Sensitive and Selective RF Front End

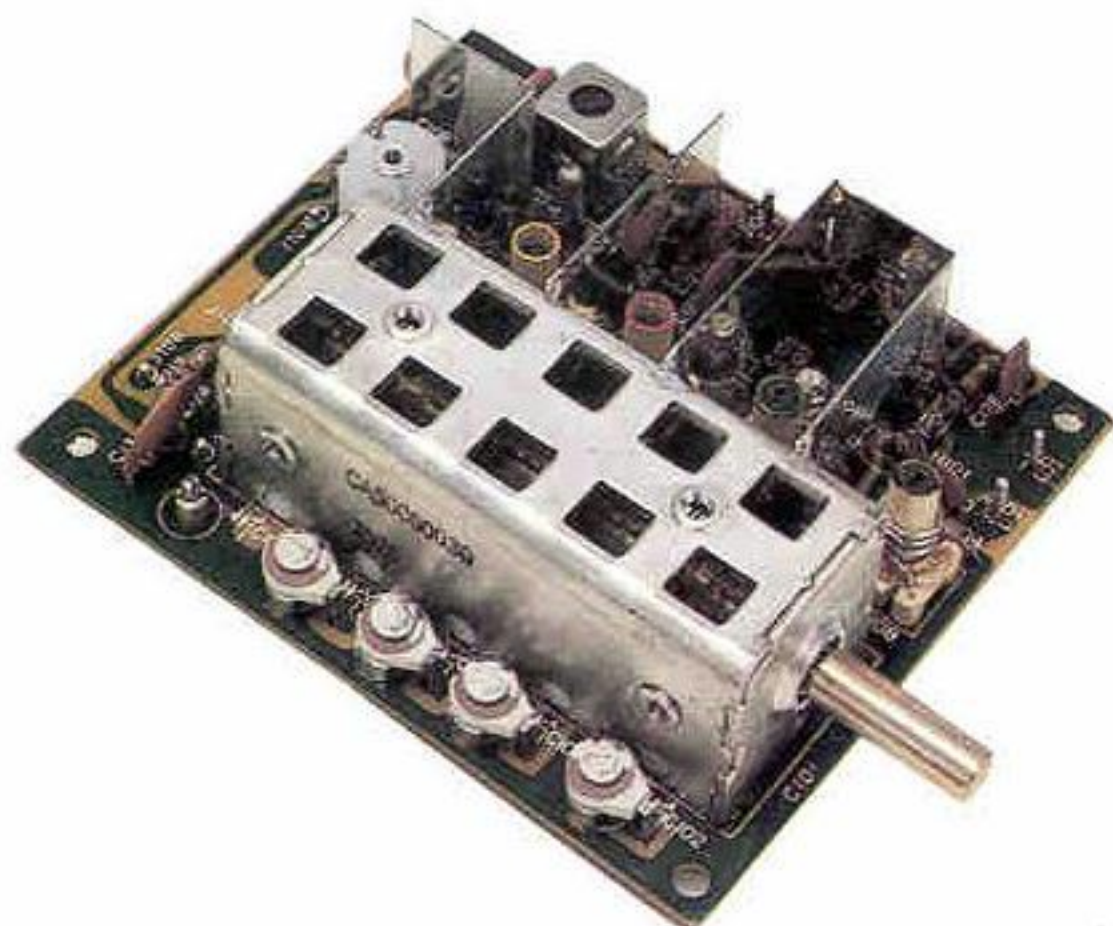

Superior selectivity is assured by a five-gang tuning capacitor in the Marantz 2325 and 2275 and a four-gang in the 2250B. A triple-tuned RF interstage on Models 2325 and 2275 and a dual-tuned RF interstage on Model 2250B provide excellent image and spurious response rejection.

Marantz FET RF amplifiers and mixer stages provide excellent spurious signal rejection and extremely low noise operation that results in excellent quieting sensitivity.

6. Phase Locked Loop FM Stereo Demodulator

The Phase Locked Loop (PLL) design was developed originally to provide a state-of-the-art communication system for the space industry. Today the same technology is used in all Marantz tuners and receivers to assure you of low distortion, excellent stereo separation and superior noise rejection.

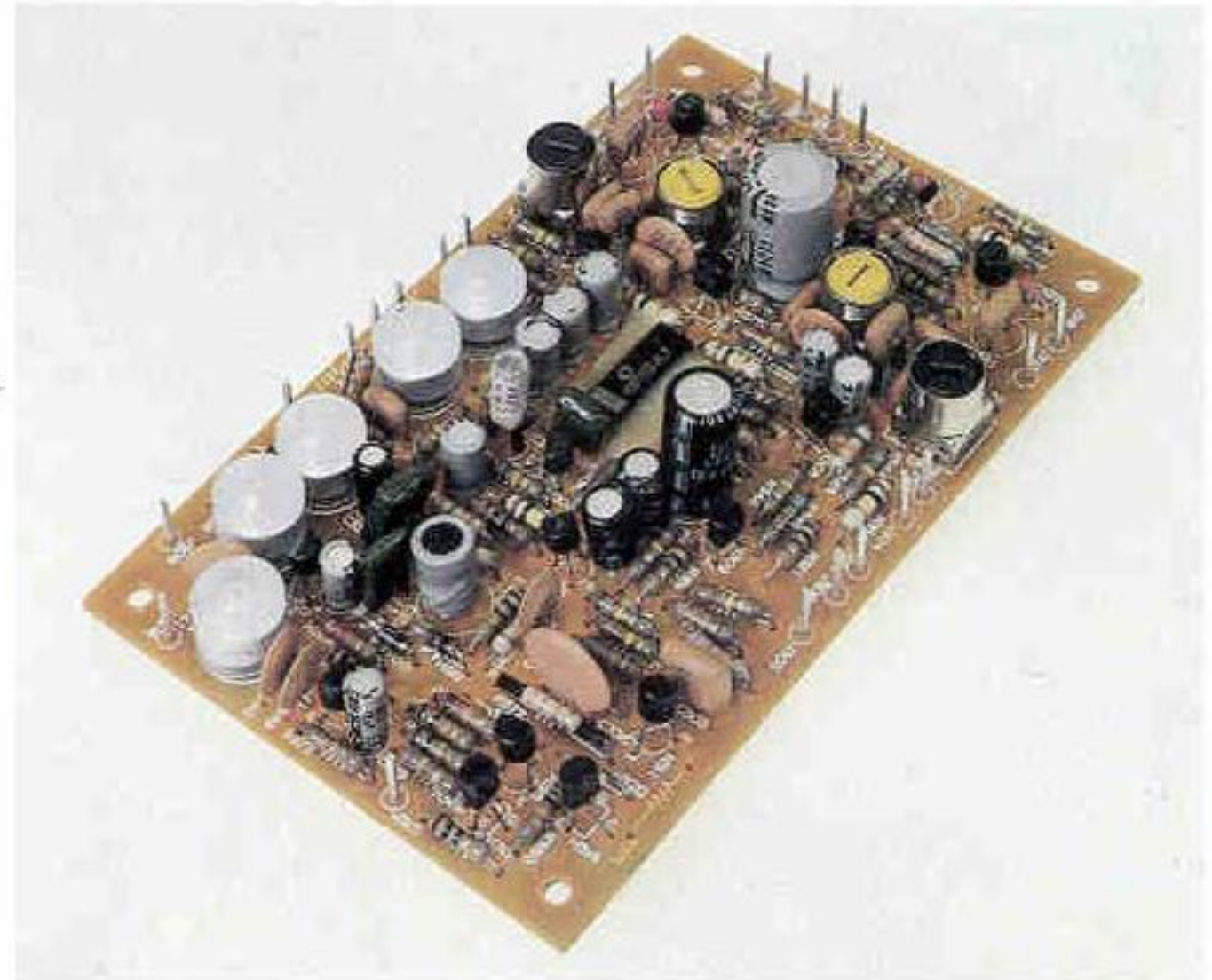

"A phase locked loop FM multiplex demodulator is used in all Marantz receivers for low distortion, excellent stereo separation and superior noise rejection."

PLL circuitry positively locks to the stereo pilot signal broadcast by an FM station. This precise "phase lock" is absolutely necessary for high performance in the stereo demodulation process: It enables the multiplex demodulator to separate the stereo channel information from the FM multiplex signal with more accuracy and less distortion than multiplex demodulators using other designs.

In addition, PLL is dependent on pilot phase and not on pilot amplitude, making it less susceptible to false triggering from various types of noise interference.

7. Ceramic IF Filters

The performance of an FM tuner is determined to a great extent by the performance of its Intermediate Frequency (IF) amplifier. The ideal IF amplifier should accept the desired band of frequencies with minimum phase distortion, while rejecting all adjacent frequency signals.

Marantz stereo receivers feature IF amplifiers consisting of ceramic filters, whose characteristics produce a 200 kHz passband that's linear in phase. This eliminates a major source of high frequency distortion and of loss of stereo separation. Sharp cut-off slopes improve the tuner's rejection and selectivity characteristics, permitting clear reception even when stations are closely spaced.

8. Positive FM Muting

FM tuning is made completely noise-free by a special parametric-type muting circuit. The circuit responds to three characteristics of the FM signal: RF noise level, RF signal strength and DC offset at the ratio detector, thus assuring positive muting of the audio signal even under the most adverse conditions.

9. FM Dolby* De-Emphasis Network

Today there are more than 100 FM stations throughout the United States broadcasting with a Dolby Noise Reduction system, and others are sure to follow. To help you receive the clean, quiet FM reception promised by these Dolbyized broadcasts, Marantz Models 2325, 2275 and 2250B incorporate a built-in 25 microsecond Dolby FM equalization circuit that provides complete de-emphasis compatibility when used with a Dolby Noise Reduction system. (NOTE: Model 2325 also has a complete Dolby Noise Reduction system built in.)

Noise from a Dolbyized FM broadcast can be reduced approximately 12 dB by changing the de-emphasis curve from 75 to 25 microseconds and utilizing the Dolby system. This is the equivalent of reducing the noise power of a received FM broadcast sixteen times below normal.

Dolby encoding allows an FM station the choice of operating with significantly reduced distortion, while still improving signal-to-noise by approximately 9 dB—or of broadcasting a signal that's effectively double in strength, with a signal-to-noise improvement of approximately 12 dB.

PREAMPLIFIER SECTION

10. Flexible Tone Controls

The more flexible the tone controls, the more accurately you can adjust for non-linearities in frequency response caused by speakers, speaker placement, room acoustics of the program source itself.

The tone control system in Marantz Models 2325, 2275 and 2250B features a sophisticated five-position tone turnover/mode switch for versatile bass, midrange and treble control. This eliminates a major shortcoming of conventional tone controls—their tendency to affect too wide a band of frequencies. Optional frequency turnover points limit the effect of the bass and treble controls to just the desired range.

The advantages can be illustrated by a practical example: Boosting the low bass (under 100 Hz) to compensate for a deficiency in room acoustics. Most conventional tone controls, even if capable of supplying the boost, will also increase the output in the 300 Hz to 1000 Hz region. With the turnover point set at 250 Hz on a Marantz receiver, the bass control can provide the desired bass boost (or cut) up to the frequency point of 250 Hz, and leave the frequency range above the point essentially flat and unaffected.

This flexible, easy-to-set system permits over seven million combinations of repeatable tone control settings, enabling you to adjust for the desired tonal balance in any listening environment.

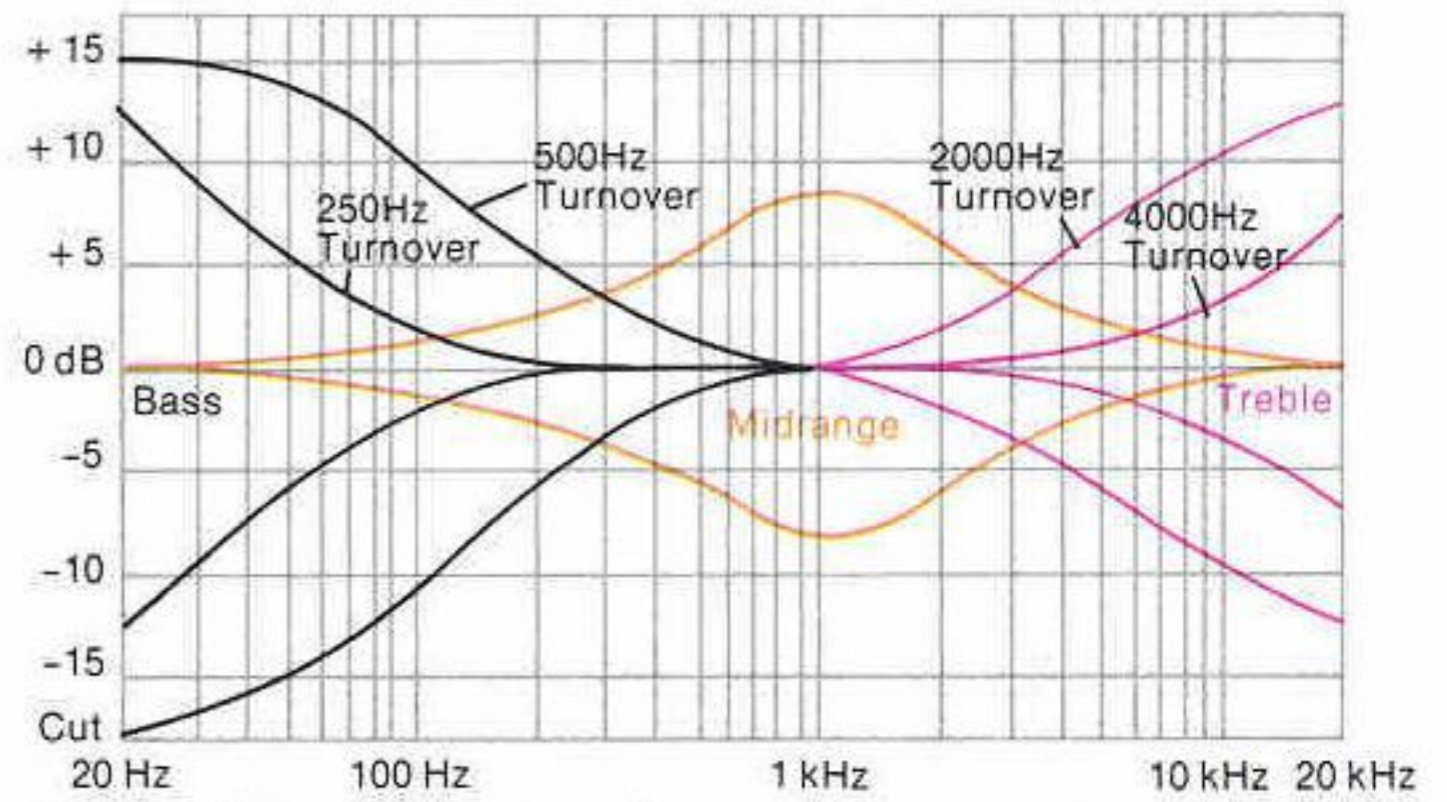

"This flexible, easy-to-set system permits over seven million combinations of repeatable tone control settings, enabling you to adjust for the desired tonal balance in any listening environment."

11. High Performance Phono Preamp

Low noise and a wide dynamic range are of paramount importance in the circuit design of a phono section.

The three-stage, 40 dB gain amplifier built into Marantz receivers utilizes feedback-equalized circuitry to maintain extremely low distortion.

The use of close tolerance, stable components, such as tantalum input coupling capacitors, low noise carbon film resistors, Mylar output coupling and polystyrene-type equalization capacitors assures superior performance.

RIAA equalization is precise—within ± 0.5 dB, from 20 to 20 kHz—and under test in the 2325, the equivalent noise input to the phono section measures a low 0.8 microvolts. The phono overload point occurs at over 100 millivolts in the 2250B, and at over 125 millivolts in the 2325 and 2275. These figures result in a dynamic range capability of greater than 96 dB.

12. A full Complement of Inputs and Outputs

In addition to the standard phono and auxiliary inputs, two sets of tape inputs and outputs are provided to facilitate copying from one tape deck to another. Front panel dubbing jacks allow you to add a third tape deck without disrupting any rear panel connections.



The preamp-out/main-in jacks on the rear panel enable you to use the preamplifier and amplifier sections independently. You get simplified connection of external components such as noise reduction systems, equalizers and electronic crossovers—and the ability to use the receiver's preamp section to drive a separate power amplifier.

Here's another benefit: Connecting the preamp section directly to a tape deck enables you to make specially equalized recordings by using the preamp's flexible tone controls.

Marantz Models 2325, 2275 and 2250B... the no-compromise stereo receivers.

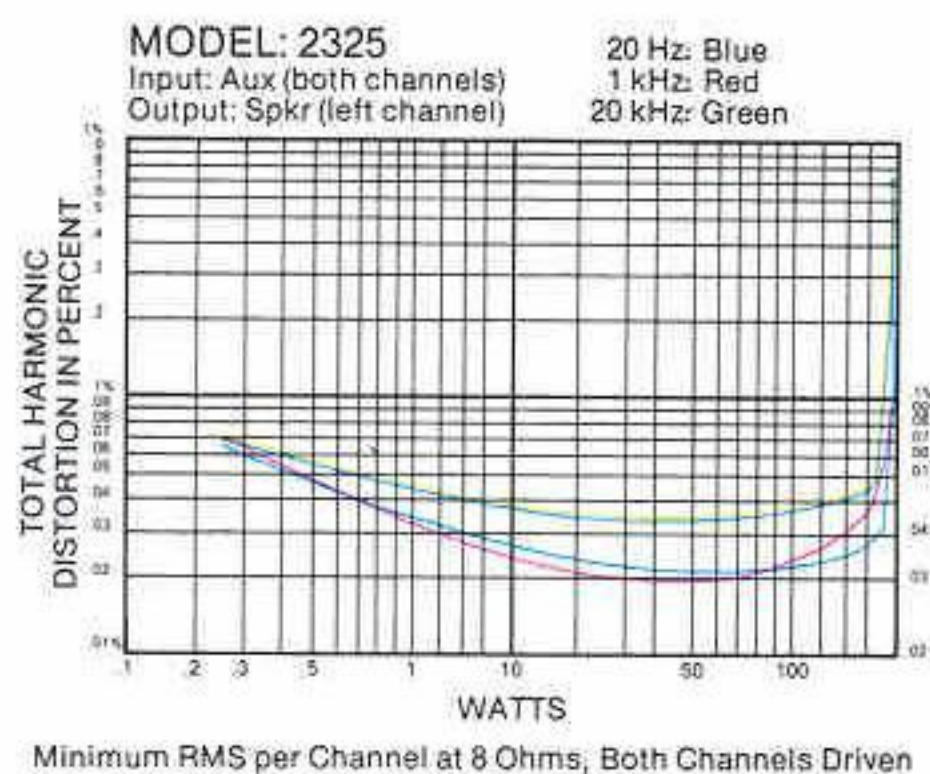
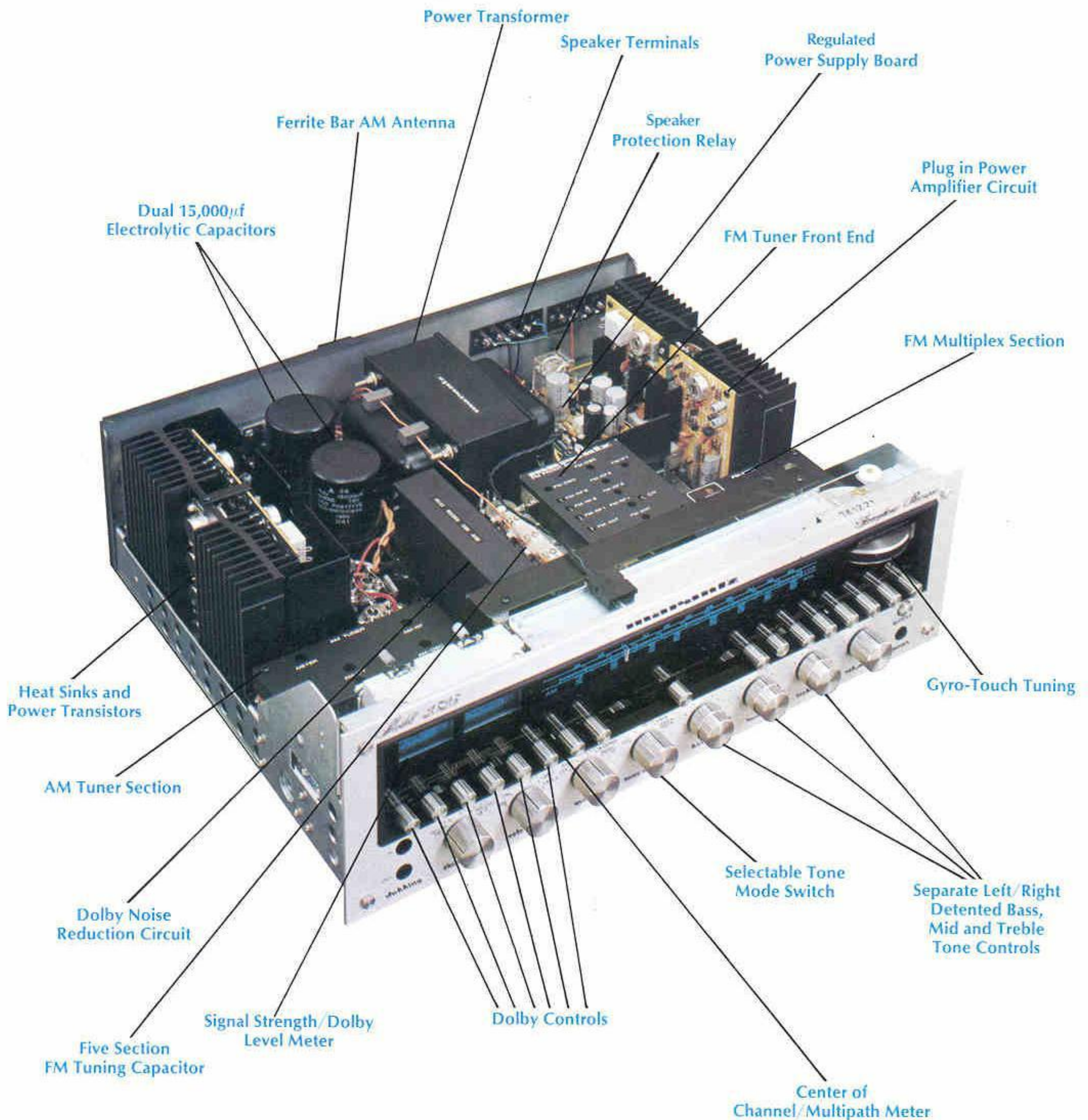

MARANTZ 2325 – "MORE THAN A STEREO RECEIVER!"

The complete built-in Dolby Noise Reduction system is one reason why. Model 2325 is the only pure-stereo receiver to give you Dolby at the control center of your sound system—where it's the most versatile. Use it: 1. to play any Dolby-encoded source, including FM broadcasts; 2. to make Dolbyized recordings from non-Dolby-encoded material; 3. to make de-processed recordings from Dolby-encoded material; and 4. to record Dolby-encoded source material and listen to the de-processed signal at the same time.

It's no wonder the Marantz 2325 is the stereo receiver all others are measured against.

*High Fidelity Magazine, August 1975. All models shown in optional cabinets.

SPECIFICATIONS FOR MARANTZ STEREO RECEIVERS

AMPLIFIER	2325	2275	2250B
Rated Power Output, Minimum Continuous Watts Per Channel, Both Channels Driven	125	75	50
Power Band	20Hz to 20kHz	20Hz to 20kHz	20Hz to 20kHz
Total Harmonic Distortion	0.1%	0.2%	0.25%
Load Impedance, ohms	8	8	8
I.M. Distortion (I.H.F. Method, 60Hz & 7kHz mixed 4 to 1 at Rated Power Output)	0.1%	0.2%	0.25%
Damping Factor @ 1kHz	70	60	55
Main Inputs			
Sensitivity	1.0V	1.0V	1.5V
Impedance	55k	75k	33k
Frequency Response (At 1W Output, 20Hz to 20kHz)	±20dB	±20dB	±20dB
PRE-AMPLIFIER			
PHONO			
Dynamic Range: Ratio of Input Overload to Equivalent Input Noise	96dB	96dB	96dB
Equivalent Input Noise (RMS, 20Hz to 20kHz)	1.5µV	1.5µV	1.5µV
Input Sensitivity & Impedance	1.8mV 47k	1.8mV 47k	1.8mV 47k
Frequency Response (re: RIAA, 20Hz to 20 kHz)	±5dB	±7.5dB	±1.0dB
HIGH LEVEL INPUTS: (Aux & Tape)			
Input Sensitivity & Impedance	180mV 100k	180mV 85k	180mV 100k
OUTPUT IMPEDANCE			
Tape Record	200	200	200
Pre-Out	900	900	900
TONE CONTROLS			
Bass: 50Hz	±12dB	±12dB	±12dB
Mid: 700Hz	±6dB	±6dB	±6dB
Treble: 15kHz	±12dB	±12dB	±12dB
AM/FM SPECIFICATIONS			
QUIETING SLOPE (Mono) 30dB QUIETING			
5µV (19.2dBf)	1.8µV (10.3dBf)	1.9µV (10.8dBf)	1.9µV (10.8dBf)
10µV (25.2dBf)	55dB	55dB	55dB
50µV (39.2dBf)	60dB	60dB	60dB
1000µV (65.2dBf) (Ultimate)	70dB	70dB	70dB
1000µV (65.2dBf) (Ultimate)	75dB	72dB	72dB
DISTORTION at 1000µV (65.2dBf, Mono)			
100Hz	0.25%	0.3%	0.3%
1000Hz	0.15%	0.25%	0.3%
6000Hz	0.3%	0.35%	0.35%
DISTORTION at 1000µV (65.2dBf, Stereo)			
100Hz	0.35%	0.4%	0.45%
1000Hz	0.3%	0.35%	0.4%
6000Hz	0.5%	0.55%	0.55%
DISTORTION (Mono and Stereo) at 50dB QUIETING			
1000Hz	0.6%	0.6%	0.6%
HUM and NOISE at 1000µV (65.2dBf)			
Mono	70dB	70dB	70dB
Stereo	60dB	60dB	60dB
FREQUENCY RESPONSE 30Hz to 15kHz			
Mono	±1.0dB	±1.0dB	±1.0dB
Stereo	±1.5dB	±1.5dB	±1.5dB
CAPTURE RATIO			
at 100µV (45.2dBf)	1.8dB	1.8dB	2.0dB
at 1000µV (65.2dBf)	1.25dB	1.5dB	1.5dB
ALTERNATE CHANNEL SELECTIVITY	80dB	80dB	65dB
SPURIOUS RESPONSE REJECTION	100dB	100dB	95dB
IMAGE RESPONSE REJECTION	100dB	100dB	70dB
I.F. REJECTION (Balanced)	100dB	100dB	100dB
AM SUPPRESSION at 100µV (45.2dBf)	62dB	62dB	60dB
STEREO SEPARATION			
100Hz	38dB	35dB	35dB
1000Hz	42dB	42dB	40dB
10kHz	30dB	30dB	30dB
PILOT (19kHz) REJECTION	65dB	65dB	60dB
AM USABLE SENSITIVITY	20µV	20µV	20µV



MODEL: 2325
Input: Aux (both channels)
Output: Spkr (left channel)

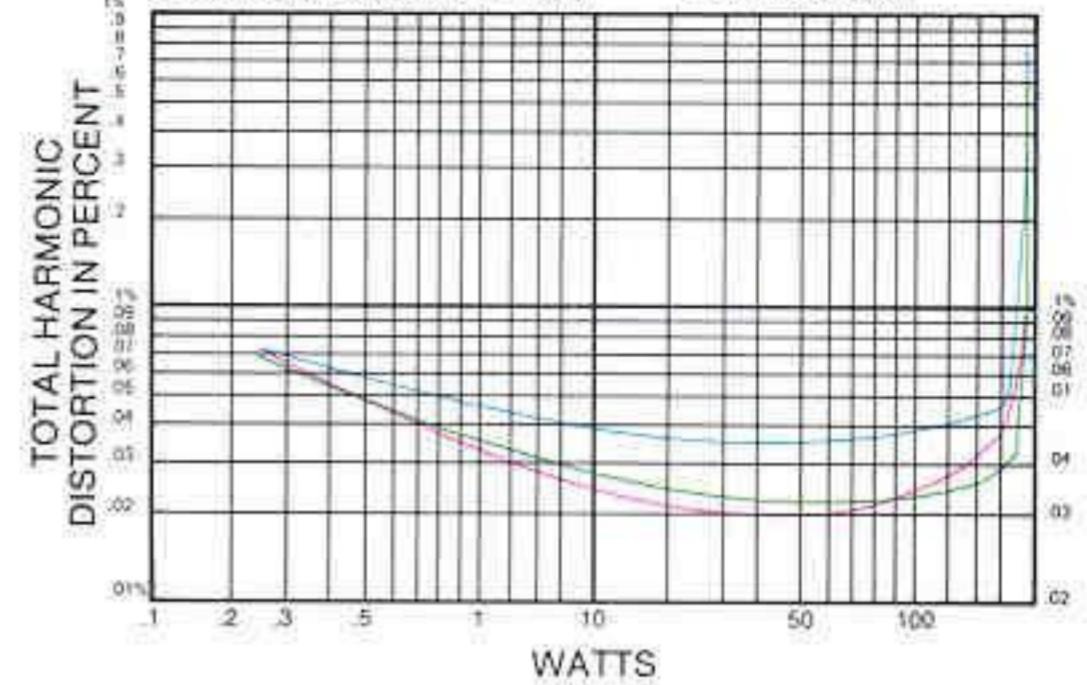

MODEL: 2275
Input: Aux (both channels)
Output: Spkr (left channel)

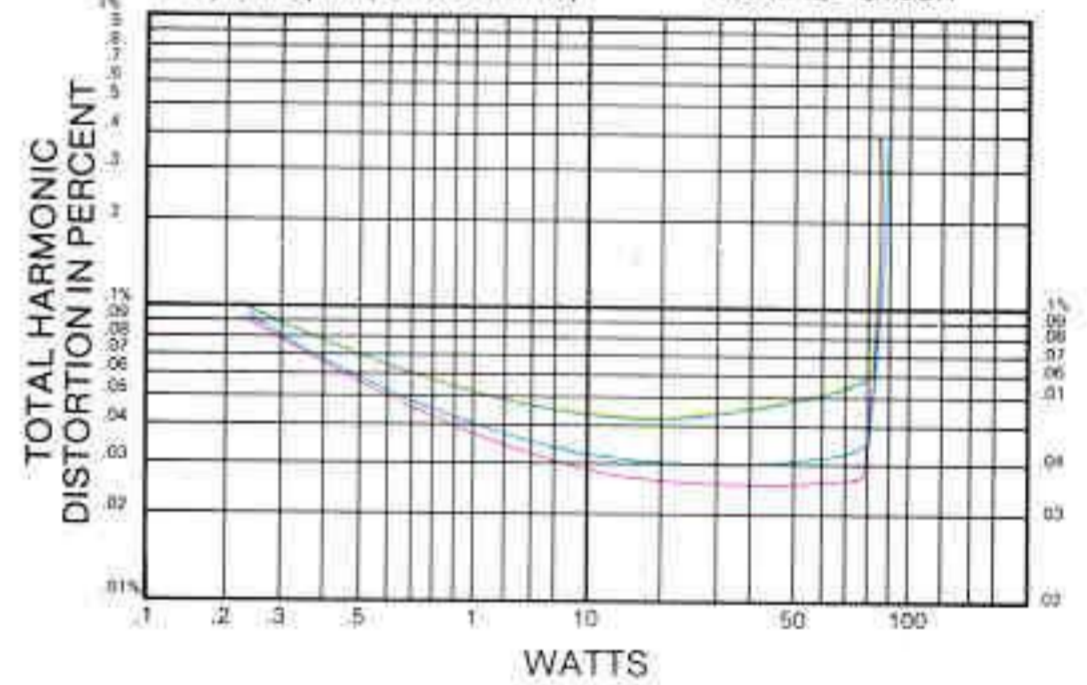

MODEL: 2250B
Input: Aux (both channels)
Output: Spkr (left channel)

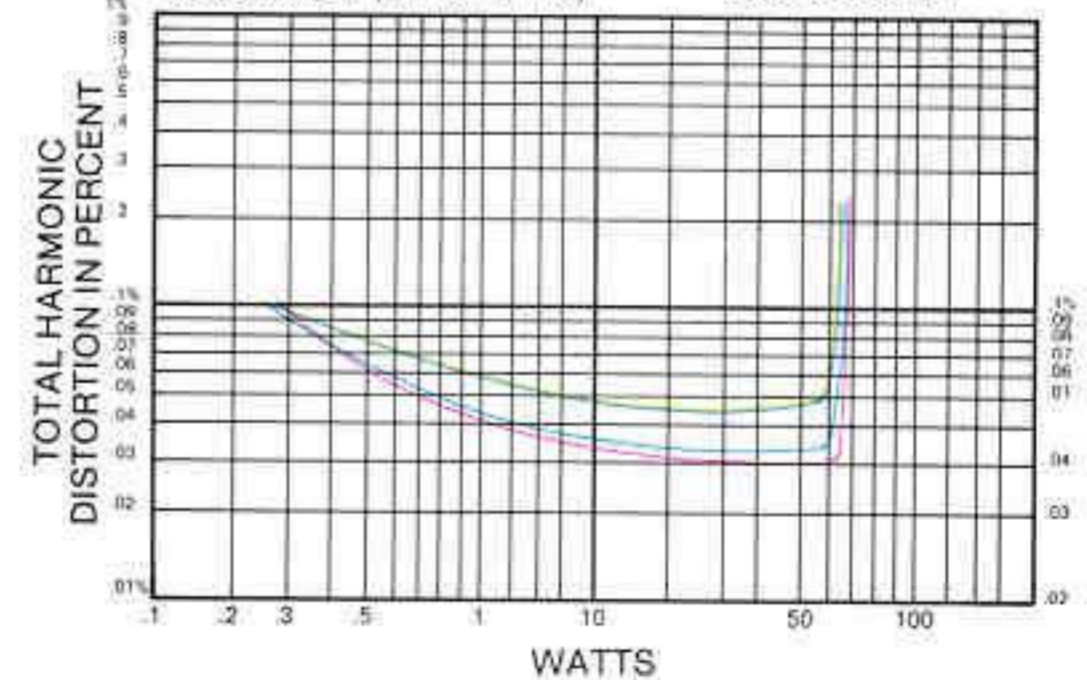

marantz
We sound better.



Model 2325

marantz

Stereophonic Receiver

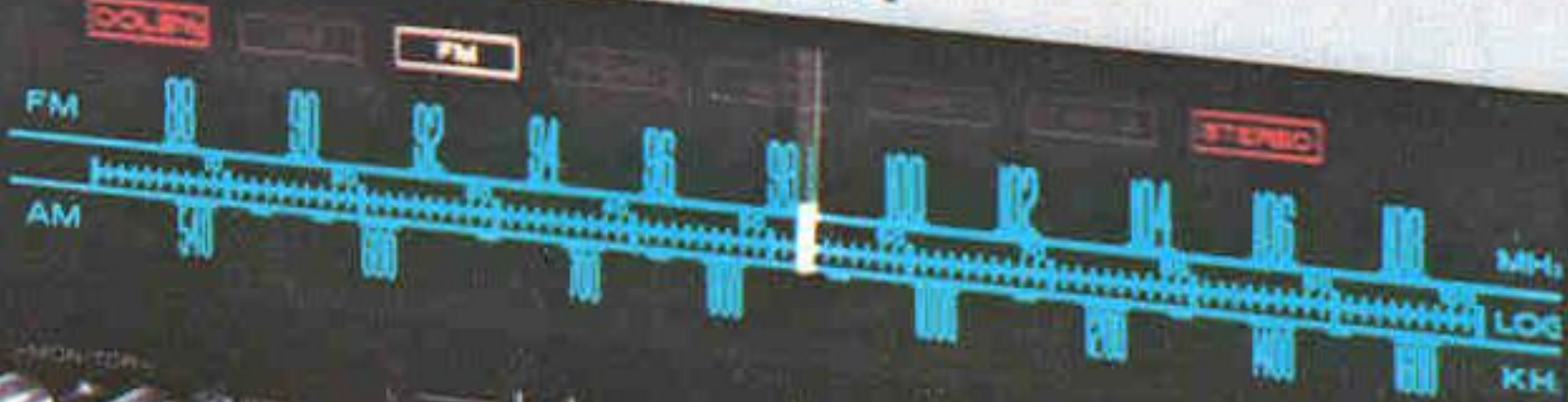

marantz Stereophonic Receiver



Model 2250B

marantz

Stereophonic

